

## Model ET: Machine Illustration and Parts List

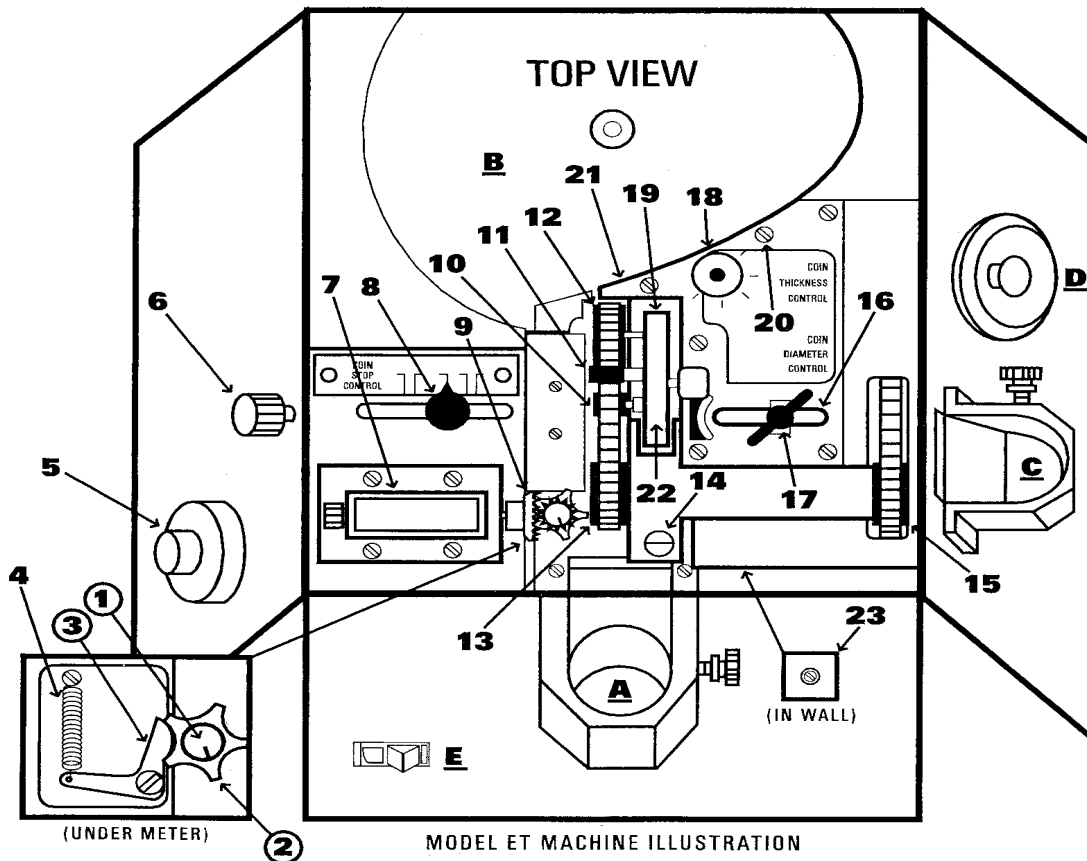

<u>Item #</u>	<u>Part #</u>	<u>Description</u>	<u>Price</u>	<u>Item #</u>	<u>Part #</u>	<u>Description</u>	<u>Price</u>
1	98-6000	Starwheel Assembly	\$261.00	16	8-2081	Knob - Diameter	\$4.00
2	8-6010	Starwheel	\$35.00	17	8-2090	Spacer - Diameter	\$61.75
3	8-5090	Pawl - Starwheel	\$15.00	18	8-2020	Knob - Thickness	\$15.00
4	8-5100	Spring - Starwheel Pawl	\$5.00	19a	278-320050025	5-40 X 1/4" Socet Set Screw	\$1.00
5	98-1100	Reset Button Assembly	N/A	19b	278-326080050	8-32 X 1/2" Slotted Set Screw	\$1.00
6	98-5050	Coin Stop Shaft Knob	N/A	20	8-2070	Pin - Height Block	\$8.00
7	8-5060	Meter Only - No Gear	N/A	21	8-2010	Block - Height	\$72.00
8	8-2080	Knob - Coin Stop	\$3.00	22	98-4085	Complete Belt Tension Arm Assembly.	\$295.00
9	98-5070	Meter Bevel Gear Assembly	N/A	23	8-1200	Pin - Lock Pivot	\$4.00
10	98-4070	Idler Pulley Assembly	\$21.50	A	98-1031	Front Tube Holder Assembly	\$75.00
11	8-4082	Roller - Belt Tension	\$3.50	B	98-3000	Disc Assembly	\$149.00
12	98-4053	Coin Drive Pulley Assembly	N/A	C	98-1032	Side Tube Holder Assembly	\$75.00
13	8-4050	Small Pulley - Upper Drive Shaft	\$15.50	D	8-1090	Knob - Bent Coin	\$25.00
14	278-332251088	J-Screw	\$1.50	E	8-1070	Switch Motor	\$16.25
15	8-4051	Large Pulley - Upper Drive Shaft	\$15.50				